

CHAPTER 2
DECK GENERAL

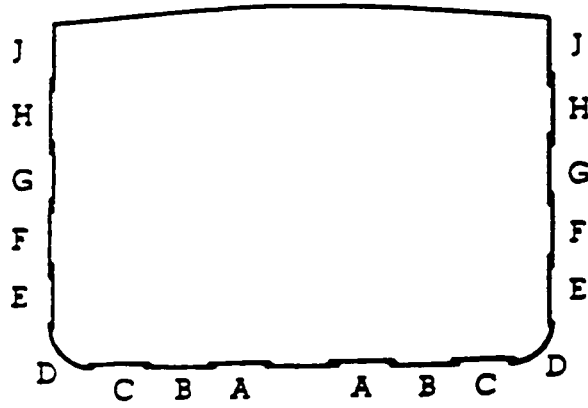

D001DG

A 

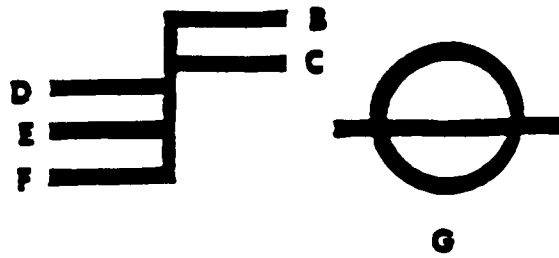

D003DG

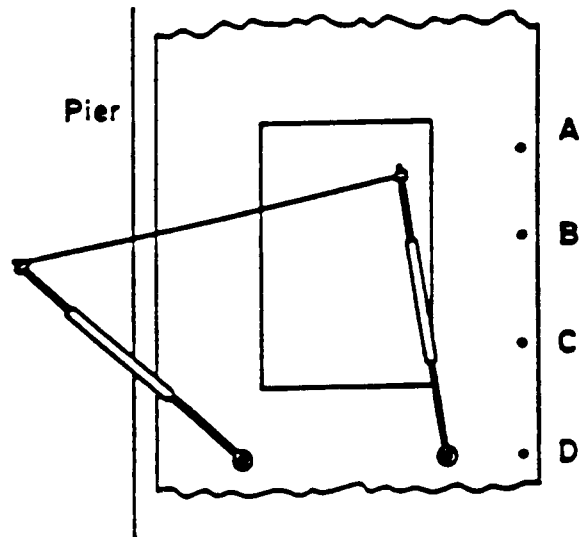

D004DG

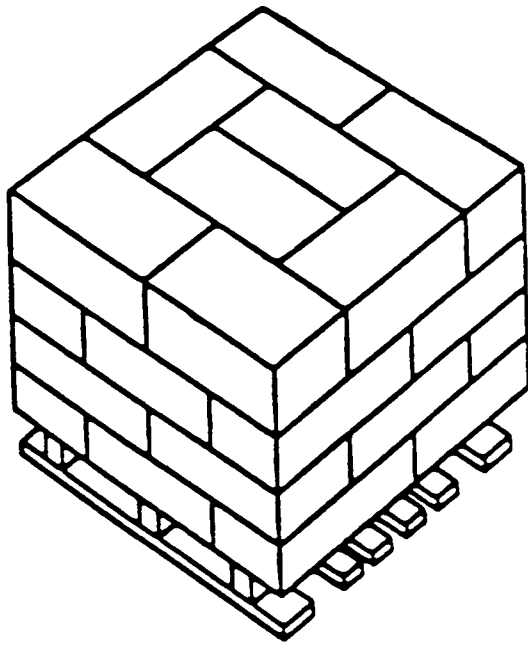

D005DG

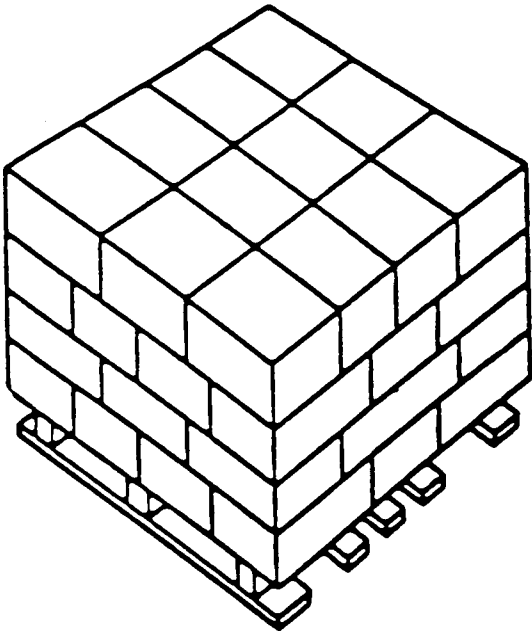

D006DG

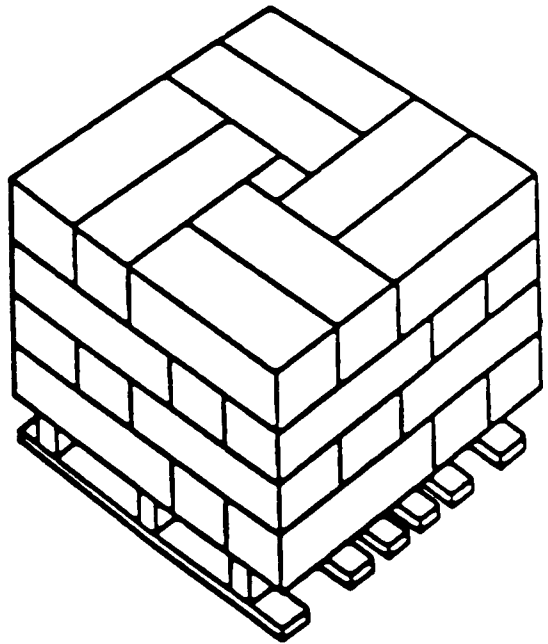

D007DG

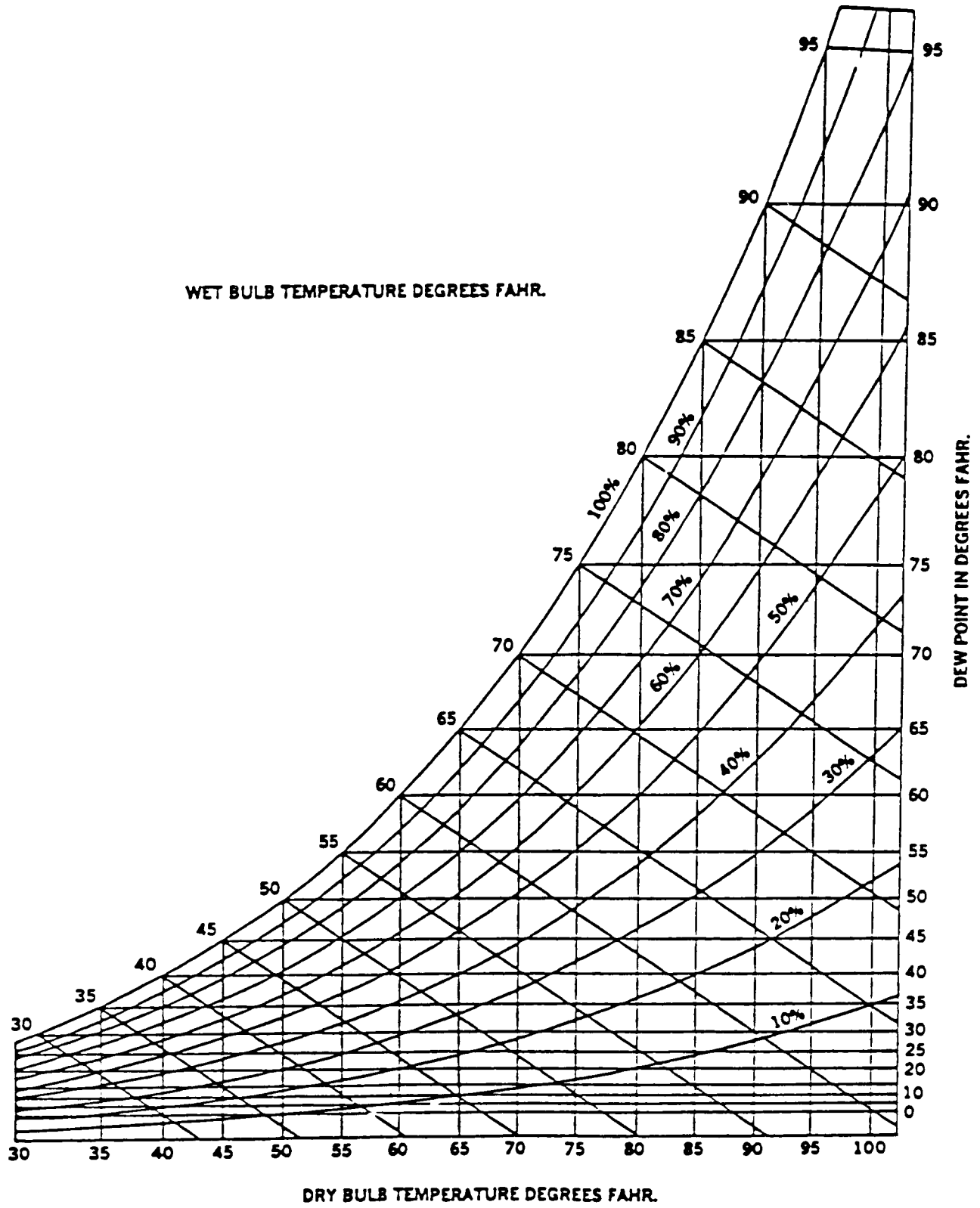

DO08DG

D009DG THROUGH D018DG: RESERVED

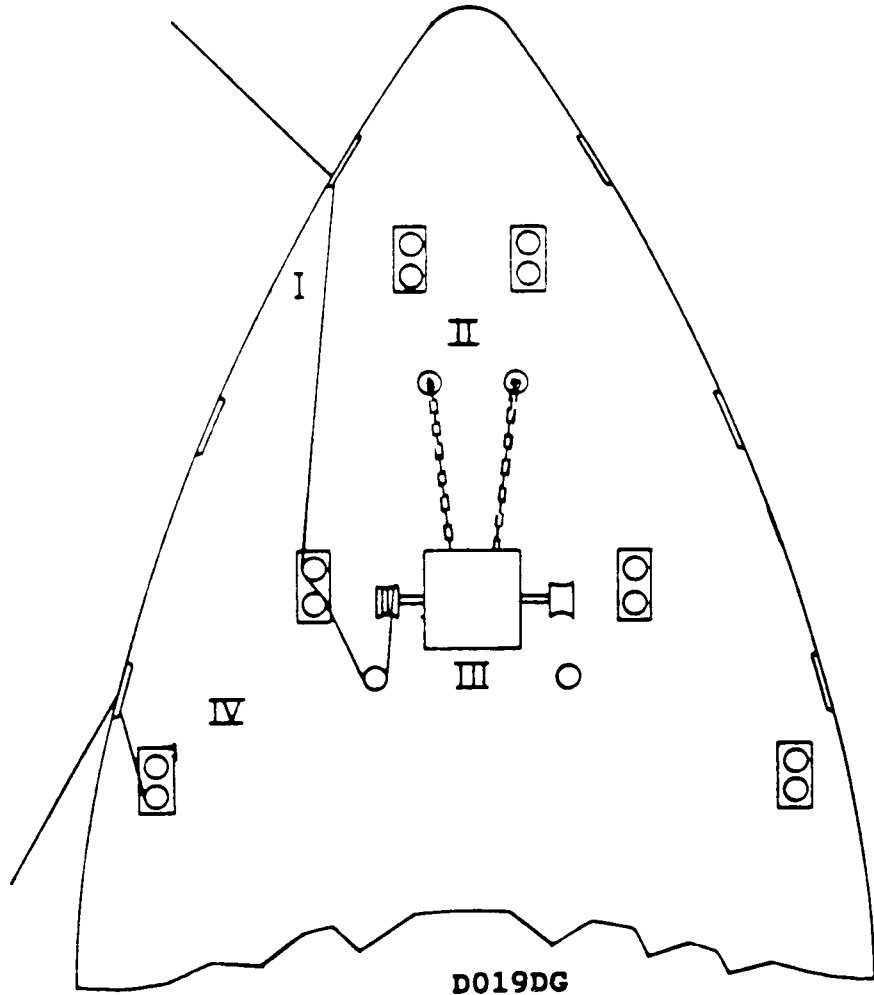

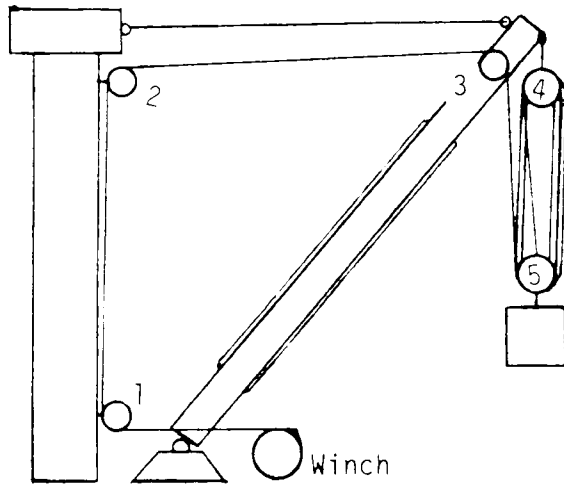

1, 2, 3 - Single sheave
fairlead blocks

4, 5 - Triple sheave
blocks

D020DG

D021DG: RESERVED

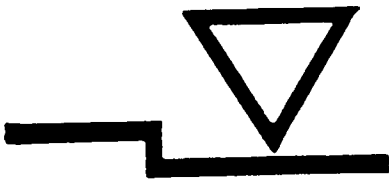

D022DG



D023DG

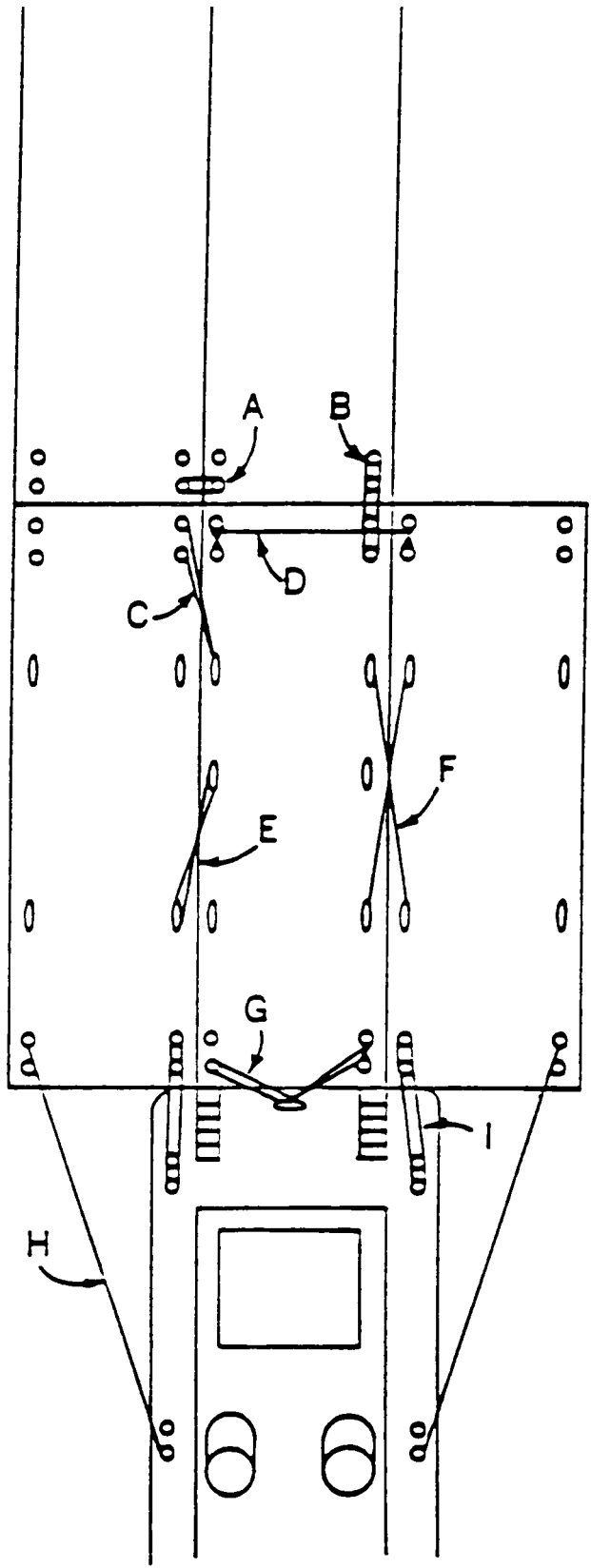

D024DG

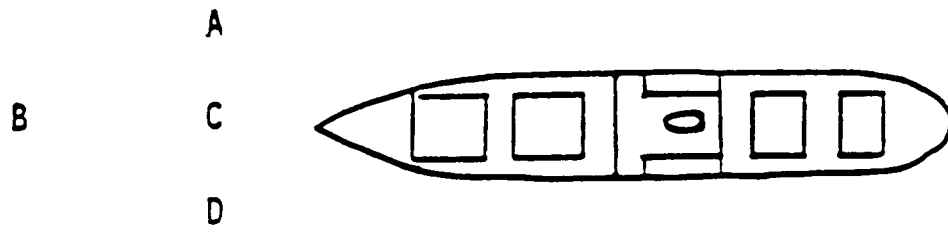

D025DG

D026DG THROUGH D028DG: RESERVED

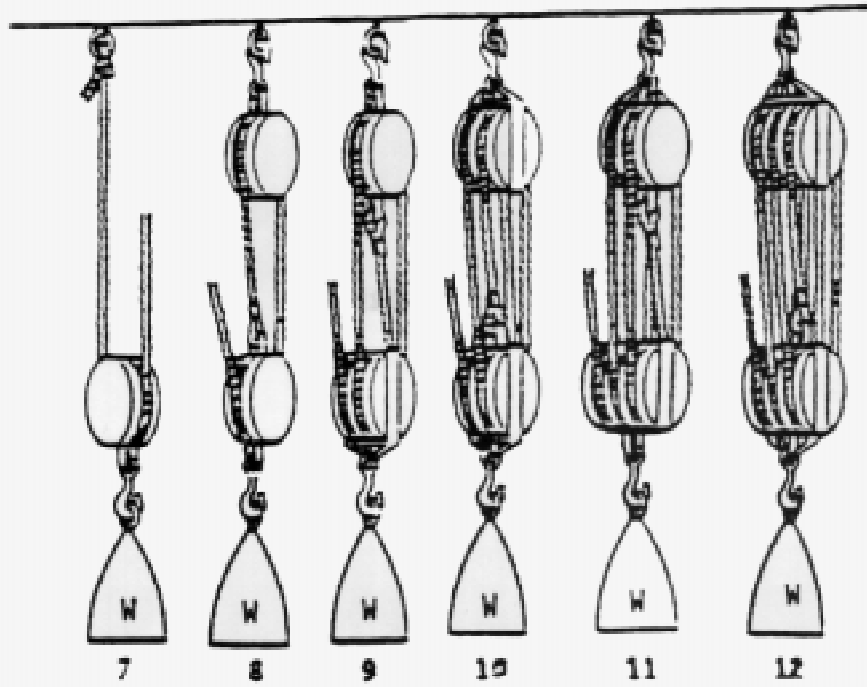
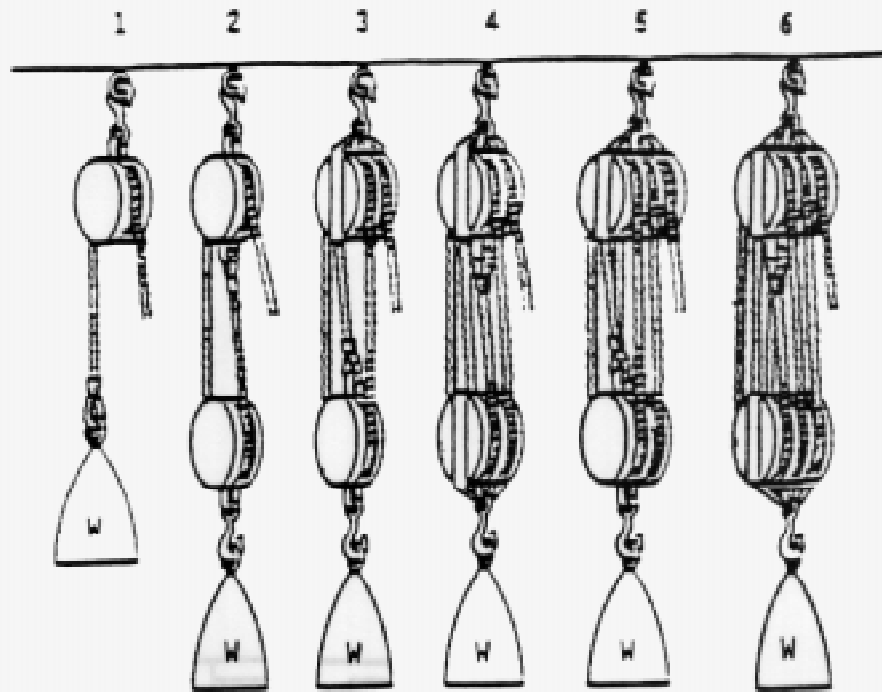

D029DG

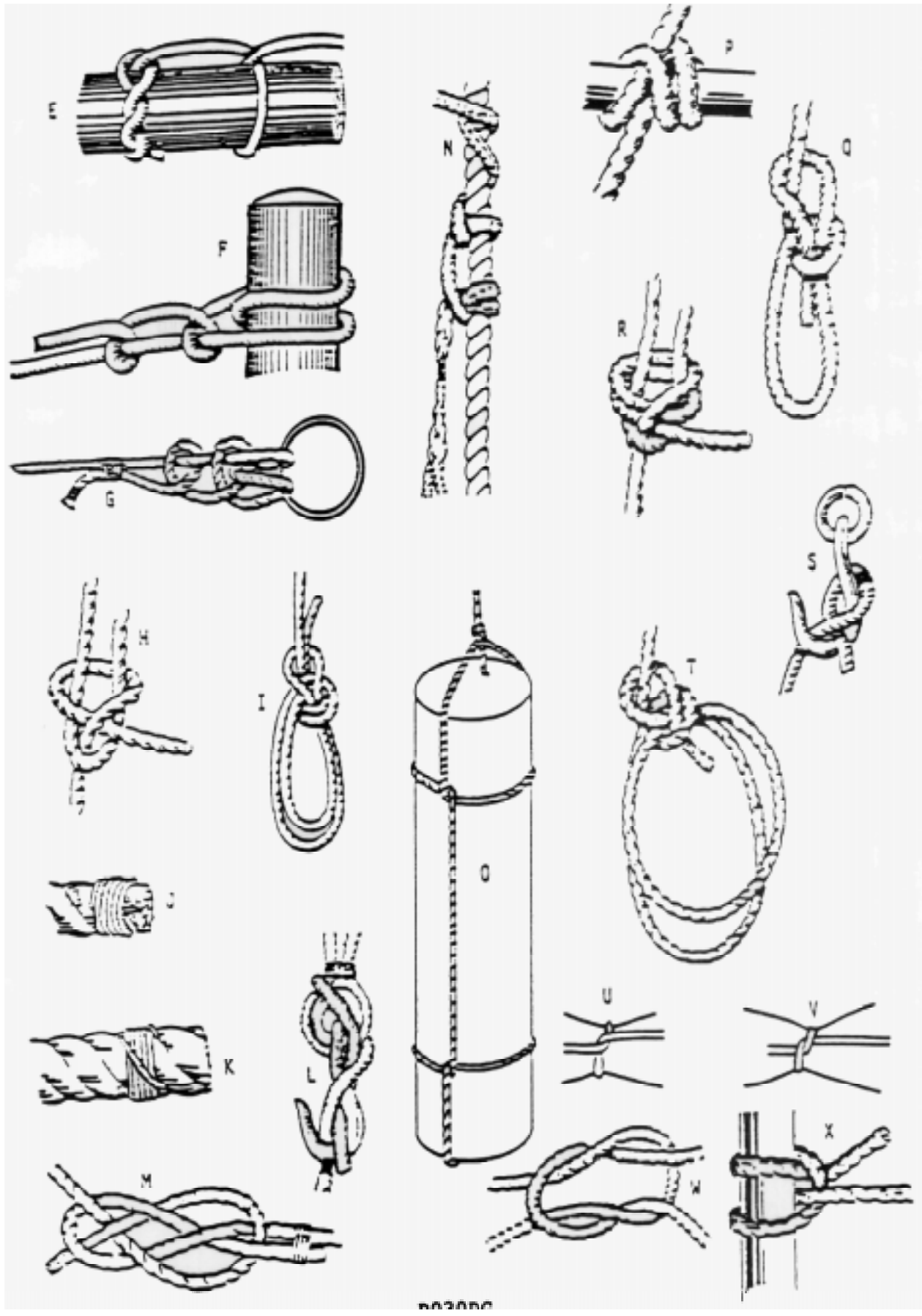

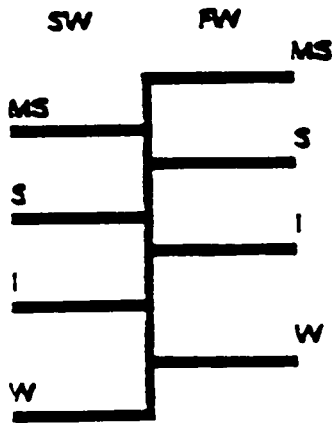
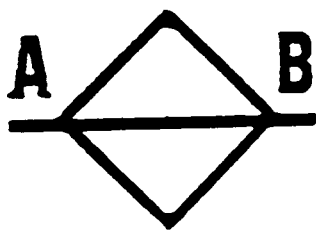

D031DG

12

12

11

11

10

10

9

9

8

8

7

7

**AFT DRAFT
MARKS**

**FWD DRAFT
MARKS**

D032DG